



Selected Products  
2018–2019





rita@yaltan.com  
peter@yaltan.com

# CALLEN & KALLEN



Constructed of die cast aluminum or one piece spun aluminum for high quality and durability. Slim edge design features a broad range of decorative purpose and enhance comfortability. Simple appearance are ideal for residential and commercial scenarios. C for round and K for Square.

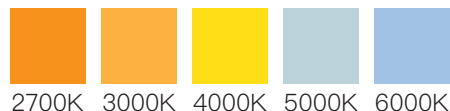

	4"	6"	8"	
<b>ELECTRICAL</b>	<b>Power Consumption(W)</b>	10	18	25
	<b>Power Factor</b>	0.53	0.56	0.55
	<b>Input Voltage(V)</b>	220-240	220-240	220-240
	<b>Frequency</b>	50/60Hz	50/60Hz	50/60Hz
	<b>Flicker Free</b>	No	No	No
<b>LIGHT</b>	<b>Lumen Output(lm)</b>	900	1620	2250
	<b>Luminary Efficacy(lm/w)</b>	90	90	90
	<b>Beam Angle(°)</b>	110	110	110
	<b>Ra</b>	80	80	80
	<b>Colour Deviation(steps)</b>	6	6	6
<b>PHYSICAL</b>	<b>Dimension(mm)</b>	120*35	175*35	225*35
	<b>Net Weight(kg)</b>	0.3	0.4	0.5
	<b>IP Rating</b>	IP20	IP20	IP20



rita@yaltan.com  
peter@yaltan.com

# CAVIN & KAVIN



Plating Options  
Bronze Nickel  
Chrome Golden  
Pearl Black Pearl White

Constructed of die cast aluminum or one piece spun aluminum for high quality and durability. Slim edge design features a broad range of decorative purpose and enhance comfortability, ideal for residential and commercial scenarios. C for round and K for Square. Six additional colors available to fulfill interior designs.

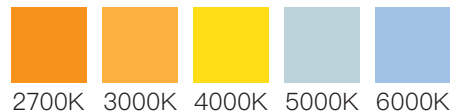

	5"	6"	8"
<b>ELECTRICAL</b>			
Power Consumption(W)	12	18	25
Power Factor	0.52	0.53	0.53
Input Voltage(V)	220-240	220-240	220-240
Frequency	50/60Hz	50/60Hz	50/60Hz
Flicker Free	No	No	No
<b>LIGHT</b>			
Lumen Output(lm)	1080	1620	2250
Luminary Efficacy(lm/w)	90	90	90
Beam Angle(°)	110	110	110
Ra	80	80	80
Colour Deviation(steps)	6	6	6
<b>PHYSICAL</b>			
Dimension(mm)	145*35	175*35	225*35
Net Weight(kg)	0.4	0.5	0.6
IP Rating	IP20	IP20	IP20



rita@yaltan.com  
peter@yaltan.com

# C LAY & K LAY



Constructed of die cast aluminum or one piece spun aluminum for high quality and durability. Recessed and anti glare design features a broad range of decor purpose and enhance comfortability. Simple appearance are ideal for residential and commercial scenarios. C for round and K for Square.

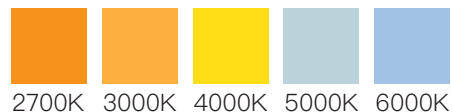

	4"	6"	8"	
<b>ELECTRICAL</b>	<b>Power Consumption(W)</b>	10	16	22
	<b>Power Factor</b>	0.53	0.56	0.55
	<b>Input Voltage(V)</b>	220-240	220-240	220-240
	<b>Frequency</b>	50/60Hz	50/60Hz	50/60Hz
	<b>Flicker Free</b>	No	No	No
<b>LIGHT</b>	<b>Lumen Output(lm)</b>	800	1280	1760
	<b>Luminary Efficacy(lm/w)</b>	80	80	80
	<b>Beam Angle(°)</b>	110	110	110
	<b>Ra</b>	80	80	80
	<b>Colour Deviation(steps)</b>	6	6	6
<b>PHYSICAL</b>	<b>Dimension(mm)</b>	120*25	170*25	220*25
	<b>Net Weight(kg)</b>	0.3	0.4	0.5
	<b>IP Rating</b>	IP20	IP20	IP20



rita@yaltan.com  
peter@yaltan.com

# DARSON



Constructed of heavy duty die cast aluminum for high quality and durability. Added bracket installation option provide more variability in applications. The Special designed heatsink enhance convection to increase performance. Ideal for storage and other industrial scenarios.

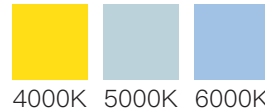

ELECTRICAL

Power Consumption(W)	100	150W	200
Power Factor	0.982	0.982	0.983
Input Voltage(V)	220-240	220-240	220-240
Frequency	50/60Hz	50/60Hz	50/60Hz
Flicker Free	Yes	Yes	Yes

LIGHT

Lumen Output(lm)	12500	18750	25000
Luminary Efficacy(lm/w)	125	125	125
Beam Angle(°)	60/90/120	60/90/120	60/90/120
Ra	80	80	80
Colour Deviation(steps)	6	6	6

PHYSICAL

Dimension(mm)	290*170	340*180	400*194
Net Weight(kg)	3.2	4.3	5.5
IP Rating	IP65	IP65	IP65



rita@yaltan.com  
peter@yaltan.com

2018NEW

# KONIG

Constructed of heavy duty die cast aluminum for high quality and durability. Added bracket installation option provide more variability in applications. The Special designed heatsink enhance convection to increase performance. Ideal for storage and other industrial scenarios.

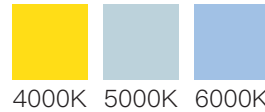

**Updated!**



*Still improving!*

ELECTRICAL	Power Consumption(W)	100	150	180W	200
	Power Factor	0.973	0.986	0.977	0.980
	Input Voltage(V)	220-240	220-240	220-240	220-240
	Frequency	50/60Hz	50/60Hz	50/60Hz	50/60Hz
	Flicker Free	Yes	Yes	Yes	Yes

LIGHT	Lumen Output(lm)	12500	18000	19800	21000
	Luminary Efficacy(lm/w)	125	120	110	105
	Beam Angle(°)	60/90	60/90	60/90	60/90
	Ra	80	80	80	80
	Colour Deviation(steps)	6	6	6	6

PHYSICAL	Dimension(mm)	280*120	280*120	310*170	310*170
	Net Weight(kg)	2.5	2.5	4.5	4.5
	IP Rating	IP65	IP65	IP65	IP65



rita@yaltan.com  
peter@yaltan.com

# PHANT



0-330°



0-70°

Constructed of die cast aluminum or one piece spun aluminum for high quality and durability. Flexible convert between downlight and spotlight feature a broad range of decorative purpose and performance. Simple appearance with powder coat finishes are ideal for residential and commercial scenarios.

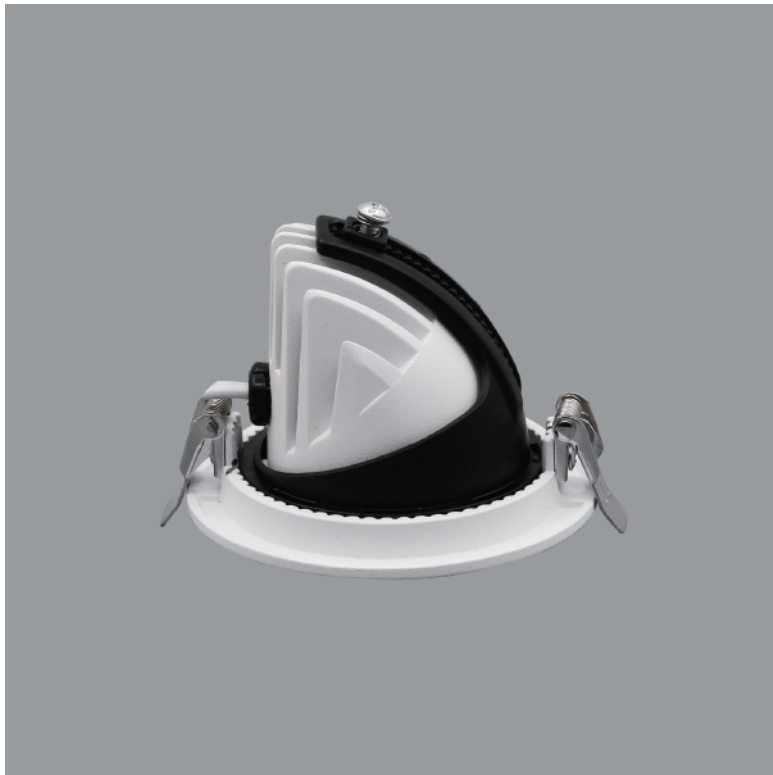
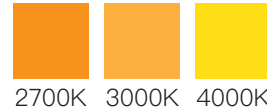

ELECTRICAL

	2.5"	3"	4"	5"
Power Consumption(W)	7	12	15	18
Power Factor	0.53	0.56	0.55	0.55
Input Voltage(V)	220-240	220-240	220-240	220-240
Frequency	50/60Hz	50/60Hz	50/60Hz	50/60Hz
Flicker Free	Yes	Yes	Yes	Yes

LIGHT

Lumen Output(lm)	560	960	1200	1440
Luminary Efficacy(lm/w)	80	80	80	80
Beam Angle(°)	60/90	60/90	60/90	60/90
Ra	80	80	80	80
Colour Deviation(steps)	6	6	6	6

PHYSICAL

Dimension(mm)	Φ74*68	Φ90*85	Φ120*110	Φ142*120
Net Weight(kg)	0.3	0.5	0.7	0.9
IP Rating	IP20	IP20	IP20	IP20



rita@yaltan.com  
peter@yaltan.com

# WENIDE

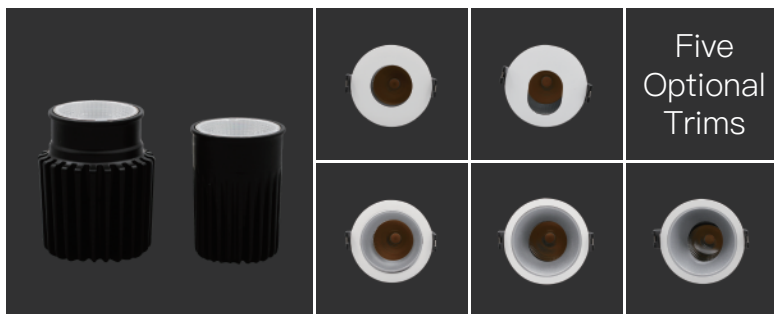

Five  
Optional  
Trims



- Reflector Options
- Copper
- Golden
- Chrome
- Black
- Frosted Silver
- Frosted Copper

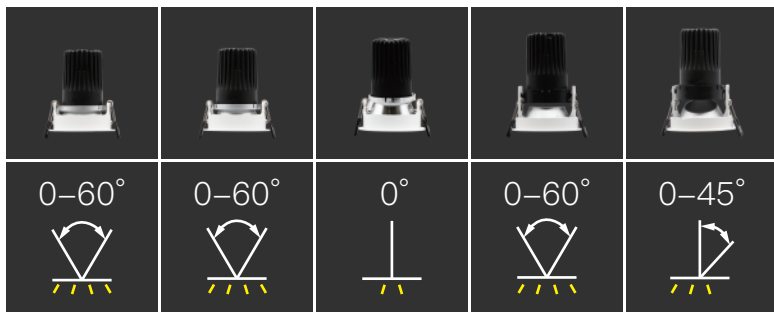

0-60° 0-60° 0° 0-60° 0-45°

Constructed of die cast aluminum or one piece spun aluminum for high quality and durability. Flexible convert between downlight and spotlight feature a broad range of decorative purpose and performance. Simple appearance with powder coat finishes are ideal for residential and commercial scenarios.

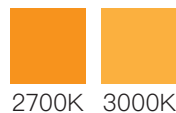

2700K 3000K

	3"	3"	
<b>ELECTRICAL</b>	Power Consumption(W)	10	15
	Power Factor	0.92	0.95
	Input Voltage(V)	220-240	220-240
	Frequency	50/60Hz	50/60Hz
	Flicker Free	Yes	Yes
<b>LIGHT</b>	Lumen Output(lm)	600	900
	Luminary Efficacy(lm/w)	60	60
	Beam Angle(°)	15/24/36	15/24/36
	Ra	90	90
<b>PHYSICAL</b>	Colour Deviation(steps)	6	6
	Dimension(mm)	Φ80*100	Φ80*110
	Net Weight(kg)	0.4	0.5
	IP Rating	IP20	IP20





rita@yaltan.com  
peter@yaltan.com

# PERISCOPE



0-315°



0-90°



Constructed of die cast aluminum or one piece spun aluminum for high quality and durability. Flexible convert between downlight and spotlight feature a broad range of decorative purpose and performance. Simple appearance with powder coat finishes are ideal for residential and commercial scenarios.



2700K 3000K 4000K

	3"	4"	5"	
<b>ELECTRICAL</b>	<b>Power Consumption(W)</b>	12	18	22
	<b>Power Factor</b>	0.55	0.55	0.55
	<b>Input Voltage(V)</b>	220-240	220-240	220-240
	<b>Frequency</b>	50/60Hz	50/60Hz	50/60Hz
	<b>Flicker Free</b>	Yes	Yes	Yes
<b>LIGHT</b>	<b>Lumen Output(lm)</b>	1020	1530	1870
	<b>Luminary Efficacy(lm/w)</b>	85	85	85
	<b>Beam Angle(°)</b>	24	24	24
	<b>Ra</b>	90	90	90
	<b>Colour Deviation(steps)</b>	6	6	6
<b>PHYSICAL</b>	<b>Dimension(mm)</b>	Φ95*105	Φ125*130	Φ145*150
	<b>Net Weight(kg)</b>	0.6	0.6	0.8
	<b>IP Rating</b>	IP20	IP20	IP20



rita@yaltan.com  
peter@yaltan.com

# SANIDEE



0-315°



0-90°

Constructed of die cast aluminum or one piece spun aluminum for high quality and durability. Flexible convert between downlight and spotlight feature a broad range of decorative purpose and performance. Simple appearance with powder coat finishes are ideal for residential and commercial scenarios.



2.5"



ELECTRICAL

Power Consumption(W)	W	12
Power Factor		0.55
Input Voltage(V)		220-240
Frequency		50/60Hz
Flicker Free		Yes

LIGHT

Lumen Output(lm)	1020
Luminary Efficacy(lm/w)	85
Beam Angle(°)	24
Ra	90
Colour Deviation(steps)	6

PHYSICAL

Dimension(mm)	Φ75*115
Net Weight(kg)	0.5
IP Rating	IP20



Yaltan Lighting Company Limited

3/F Building 1 Xinyang Road No.10

Xiamen China 361026

T: +86 592 608 7759

Fax: +86 592 608 7756



[www.yaltan.com](http://www.yaltan.com)